

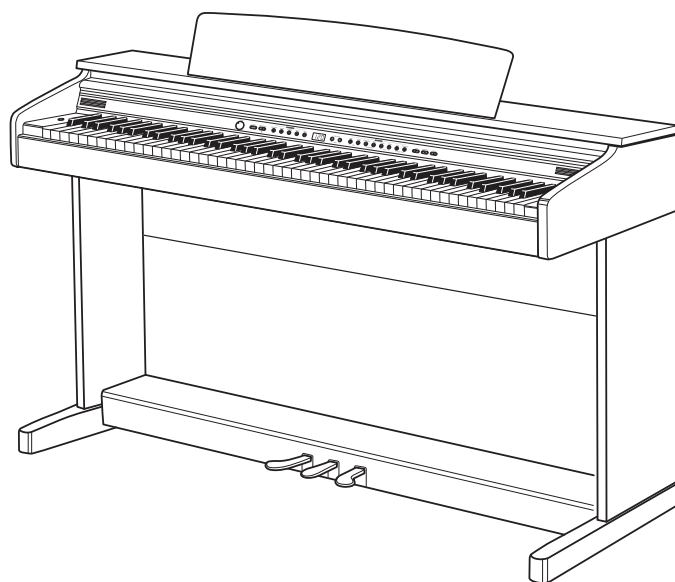

# OWNER'S MANUAL

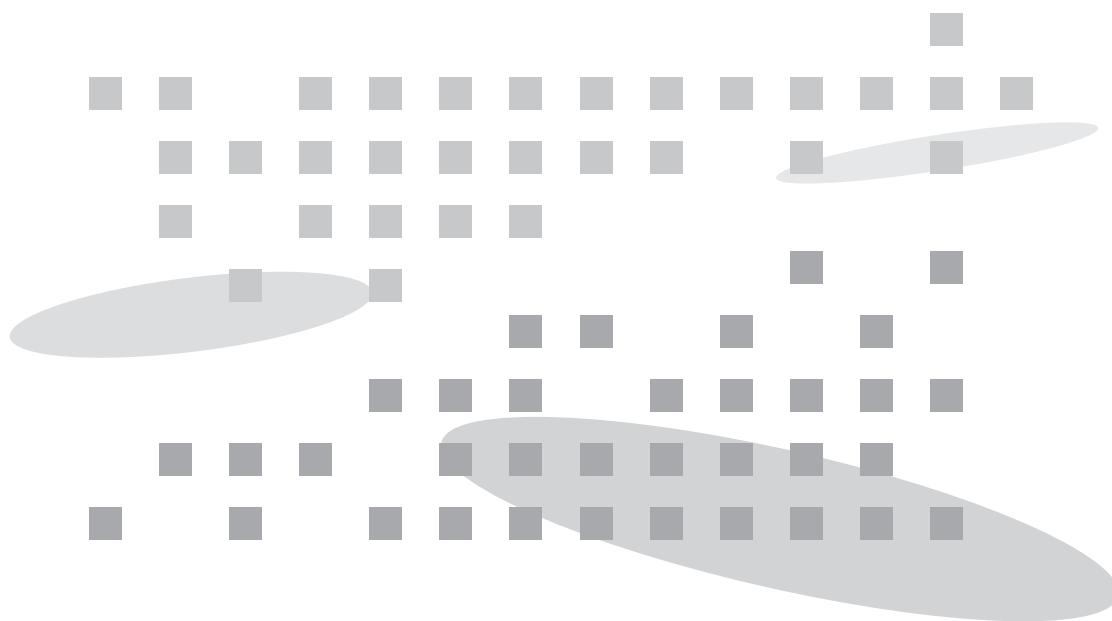

***Dynatone Digital Piano SLP-50***  
*New feel, new look and new sound*

# PRECAUTIONS

## **PLEASE READ CAREFULLY BEFORE PROCEEDING**

Please keep these precautions in a safe place for future reference.



### **WARNING**

**Always follow the basic precautions listed below to avoid the possibility of serious injury or even death from electrical shock, short-circuiting, damages, fire or other hazards. These precautions include, but are not limited to, the following:**

- Do not open the piano or attempt to disassemble the internal parts or modify in anyway. The piano contains no user-serviceable parts. If it should appear to be malfunctioning, discontinue use immediately and have it inspected by qualified service personnel.
- Do not expose the piano to rain, use it near water or damp or wet conditions, or place containers on it containing liquids which might spill into any openings.
- If the power cord or plug becomes frayed or damaged, or if there is a sudden loss of sound during use of the piano, or if any unusual smells or smoke should appear to be caused by it, immediately turn off power switch, disconnect the electric plug from outlet, and have the inspected by qualified service personnel.
- Only use the voltage specified as correct for the piano. The required voltage is printed on the name label of the piano.
- Before cleaning the piano, always remove the electric plug from the outlet. Never insert or remove an electric plug with wet hand.
- Check the electric plug periodically and remove any dirt or dust which may have accumulated on it.



## CAUTION

**Always follow the basic precautions listed below to avoid the possibility of physical injury to you or others, damage to the piano or other property. These precautions include, but are not limited to, the following:**

- Do not place the power cord near heat sources such as heaters or radiators, and do not excessively bend or otherwise damage the cord, place heavy object on it or, place it in a position where anyone could walk on, trip over or roll anything over it.
- When removing the electric plug from the piano or an outlet, always hold the plug itself and not the cord. Pulling by the cord can damage it.
- Do not connect the piano to an electrical outlet using a multiple-connector. Doing so can result in lower sound quality, or possibly cause over-heating in the outlet.
- Remove the electric plug from the outlet when the piano is not to be used for extended periods of time, or during electrical storms.
- Before connecting the piano to other electronic components, turn off power for all components. Before turning the power on or off for all components, set all volume levels to minimum.
- Do not expose the piano to excessive dust or vibrations, or extreme cold or heat such as in direct sunlight, near heater, or in the car during the day to prevent the possibility of panel disfiguration or damage to the internal components.
- Do not use the piano near other electrical products such as televisions, radios, or speakers, since this might cause interference which can affect proper operation of other products.
- Do not place the piano in an unstable position where it might accidentally fall over.
- Before moving the piano, remove all connected cables
- When cleaning the piano, use a soft, dry cloth. Do not use paint thinners, solvent, cleaning fluids or chemical-impregnated wiping cloths. Also, do not place vinyl, plastic or rubber object on the piano, since might discover the panel or keyboard.
- Do not rest your weight or place heavy objects on the piano.
- Do not use excessive force on the buttons, switches and connectors.
- Take care that the key cover does not pinch your fingers, and do not insert a finger or hand in the key cover gap.
- Never insert or drop paper or metallic or liquids or other objects between the slits of the key cover and keyboard. If this happens, immediately turn off the power and remove electric plug from outlet and inspect by qualified service personnel.
- Do not place the piano against a wall (allow at least 3 cm/one inch from the wall), since this can cause inadequate air circulation, and possibly result in the piano overheating.
- Read carefully the 'GENERAL GUIDE' section in this manual. Failure to assemble the piano in the proper sequence might result in damage to the piano or even injury.
- Do not operate the piano for a long period of time at a high or uncomfortable volume level, since this can cause permanent hearing loss. If you experience any hearing loss or ringing the ears, consult a physician.
- During thunderstorms, turn the product off and disconnect the plug from the power.

## Welcome

---

Thank you and congratulations on your purchase of a Dynatone digital piano.

Your new Dynatone digital piano is a state-of-the-art musical instrument which incorporates the latest electronics technology to make its operation as easy as possible.

In addition to the many features usually found on digital pianos, this contains a variety of educational resources that can be used for the learning of musical concepts and piano skills.

Your digital piano is ideal for beginners or experienced musicians.

The piano's compact size will allow it to fit into many placed compared to a traditional piano or large digital piano.

Its slim stylish design will match most home interiors.

In order to enjoy and utilize the features and functions of this unit to their fullest, be sure to carefully read this manual and follow the instructions contained herein.

## Main Features

---

### 16 Instruments

Grand Piano 1/2, Harpsichord, Vibraphone, Elec. Piano 1/2, Organ 1/2, Elec. Organ 1/2, Strings 1/2, Bass 1/2, Drum set, Sound effect set

### 50 Demo Music

There are 50 classical music in your digital piano. You can playback the music for your own listening pleasure, or you can use them for practice.

### 2-Track Recording and Playback

The digital piano features comprehensive song recording functions that allow you to record your own performance.

### USB port

The digital piano can be connected to a PC via USB device port and MIDI data and Audio data can be exchanged between them.

### Useful Functions

There are many useful functions in your digital piano such as metronome, twin piano, audio in/out, 2 headphones, tuning, transpose, layer and split.

### Auto-Power-Off

This digital piano is designed to turn off automatically to save power without operation for 30 min.

# Table of Contents

<b>PRECAUTIONS</b>	<b>1</b>	<b>Recording</b>	<b>20</b>
WARNING	1	Recording and Playback	20
CAUTION	2	<b>Demo Music</b>	<b>21</b>
Welcome	3	Playback of the Music	21
Main Features	3	Demo Music List	22
<b>Table of Contents</b>	<b>4</b>	<b>Drum and SFX Table</b>	<b>23</b>
<b>Unpacking</b>	<b>5</b>	<b>MIDI Implementation</b>	<b>24</b>
<b>Setting Up Your Piano</b>	<b>6</b>	<b>Troubleshooting</b>	<b>25</b>
<b>Controls and Terminals</b>	<b>8</b>	<b>Specifications</b>	<b>26</b>
Turning ON the Power	8		
Headphone	8		
Connecting to Audio Devices	9		
Connecting to a Computer	9		
Connecting to the Pedal	10		
Control Panel	11		
<b>Basic Operation</b>	<b>13</b>		
Adjusting the Volume	13		
Selecting Voices	13		
Layer	14		
Split	14		
Changing the Split Point	15		
Reverb	15		
Using the Metronome	16		
Twin Piano	16		
<b>Function</b>	<b>17</b>		
Tune	17		
Transpose	17		
Touch	18		
MIDI Local control	18		
Sound Setting and Initializing Digital Piano	19		

# Unpacking

Carefully remove the digital piano and its accessories from the packing box. The digital piano set consists of the following items.

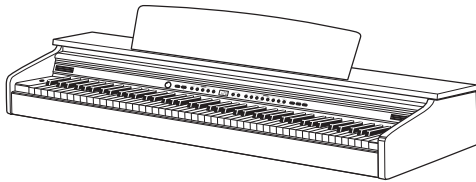

Main Unit (a)

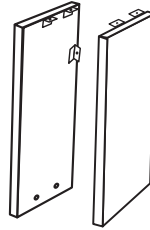

Right, Left Legs (b)

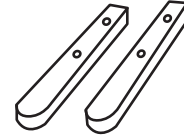

Right, Left Feet (c)

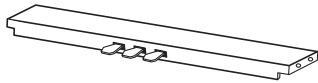

Pedal Board (d)

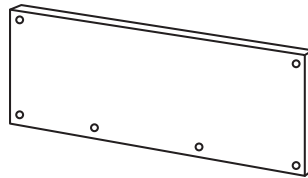

Back Panel (e)

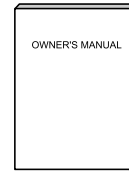

Owner's Manual



4 Bolt Caps (f)



6 Washers (i)



2 Bolts for back panel - leg (k)  
M4 X 12 mm

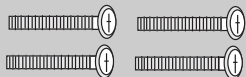

4 Bolts for foot-leg (g)  
M6 X 30 mm

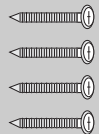

4 Screws for back panel -  
pedal board (j)  
4 X 15 mm

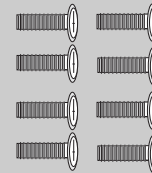

8 Bolts for main unit and  
pedal board (l)  
M6 X 25 mm



4 nuts for foot-leg (h)

☞ Inspect each item carefully to make sure that it is in good condition. If you find any item missing or damaged, contact the place of purchase immediately for replacement.

# Setting Up Your Piano

## 1 Attaching both legs and pedal board assembly

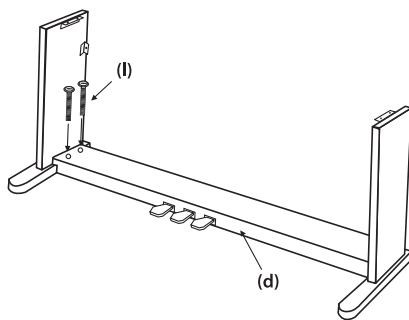

1 Assemble **Leg (b)** and **Foot (c)** using **Bolt (g)** and **Nut (h)**. And put **Bolt Cap (f)** into the bolt hole as below illustration.

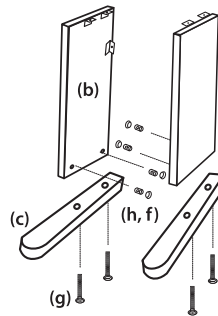

2 Securely combine left and right legs to **Pedal Board (d)** using four **Bolts (l)**.

## 2 Assembling the stand

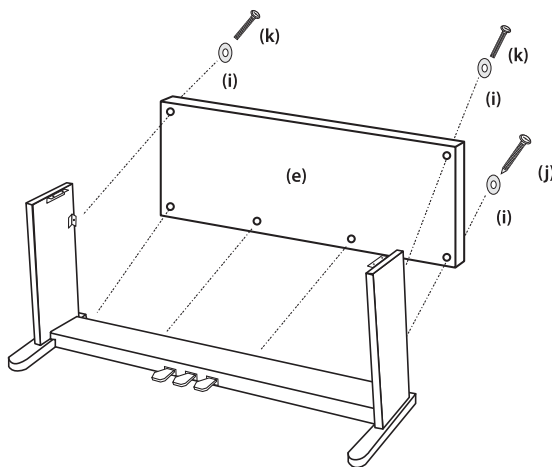

1 Attach **Back Board (e)** into the legs and pedal board using 2 **Bolts (k)** and 4 **Screws (j)** with 6 **Washers (i)**.

2 After fixing the back panel to the legs, set the stand upright and make sure the stand is parallel.

### 3 Attaching the main unit and stand

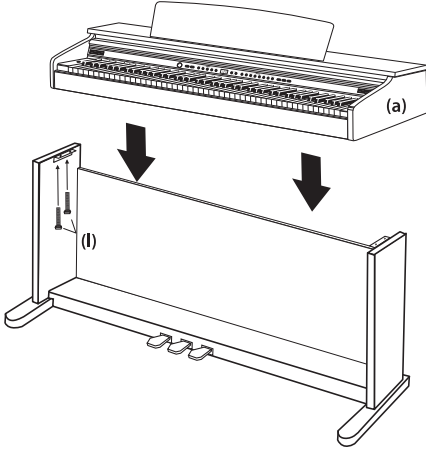

1 Set the stand upright and gently lower the main unit on to the stand, then tighten the main unit with four **Bolts (1) for Main Unit(a)** as shown in the illustration.

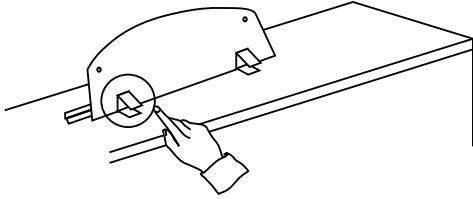

2 Raise and hold the music stand using two metal supports on the rear of music stand.

### 4 Connecting the pedal cord and AC adapter

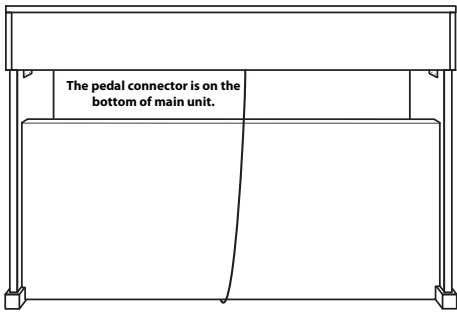

Plug the **Pedal Cord**, **AC adapter** and **Speaker Cord** into the corresponding ports on the bottom of the main unit as shown in the illustration.

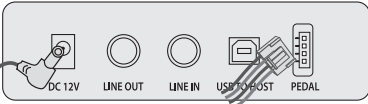

Names of each connector are printed on the rear of main unit.



# Controls and Terminals

## Turning ON the Power

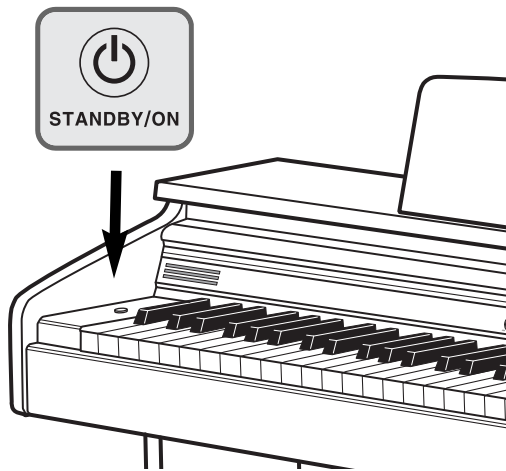

① Connect the **AC POWER ADAPTER**.  
Insert DC plug of the AC adapter into the piano and AC plug of the AC adapter into a household AC power outlet.

☞ See 'Connecting the pedal cord and AC adapter' on page 7.

② Turn on **POWER**  
Press the **STANDBY/ON** switch. The power is turned on and the initial display appears in the Multi Function Display.

☞ The voice of Grand Piano is selected automatically.

☞ Adjust the volume by using **MASTER VOLUME**.

### Auto Power Off

This digital piano is designed to turn off automatically to save power without operation for 30 min.

### Disable Auto Power Off

While holding down both lowest white and black keys, press the **STANDBY/ON** button to turn on piano without APO.

### ③ Turn off **POWER**

Press and hold the **STANDBY/ON** switch for 3 seconds.  
All lights and the LED display will turn off.

### ☞ **Backing Up the recorded song**

Even if the power is turned off, the recorded song memory is not deleted.

## Headphone

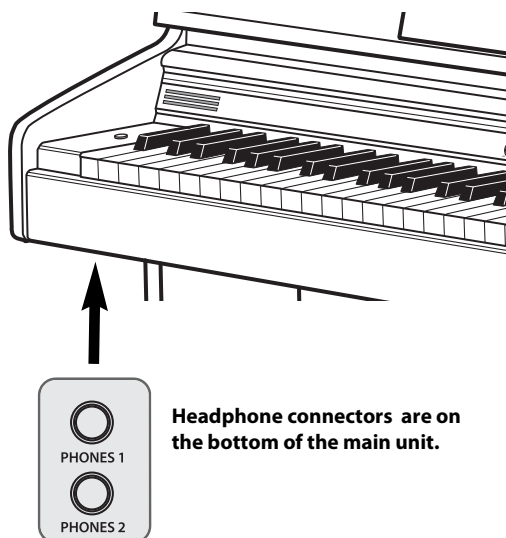

Headphone connectors are on the bottom of the main unit.

Connect a set of stereo headphones (optional) to **HEADPHONE jack** (standard 1/4" phone jacks). Insert the headphone plug into the **HEADPHONE jack** on the bottom panel of the piano. When headphones are connected, the internal speaker system is automatically shut off.

Since the piano has two **HEADPHONE jacks**, two sets of headphones can be used simultaneously, allowing two people to enjoy listening to the performance.

## Connecting to Audio Devices

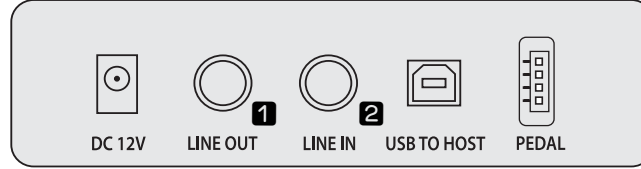

Connectors are on the bottom of the main unit

### 1 LINE OUT jack (Stereo Phone jack)

Connect the instrument's **LINE OUT** jack and the input jacks of a pair of powered speakers using appropriate stereo audio cable.

### 2 LINE IN jack (Stereo Phone jack)

Connect the output jack (LINE OUT etc.) of an external synthesizer or the tone generator module and the instrument's **LINE IN** jack using appropriate stereo audio cable. The stereo outputs from another instrument can be connected to this jack, allowing the sound of an external instrument to be reproduced via the instrument's speakers. When this is connected, you can use the instrument's **MASTER VOLUME** control to adjust the volume of the sound output to the external device.

#### CAUTION

When the sound of an external device is output to the instrument, first turn on the power to the external device, then to the instrument. Reverse this order when you turn the power off.

## Connecting to a Computer

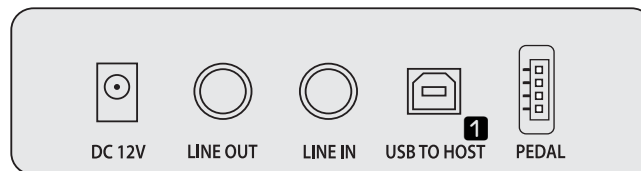

Connectors are on the bottom of the main unit

By connecting a computer to the USB, you can transfer MIDI and audio data between the instrument and the computer and take advantage of sophisticated computer music programs. When connecting to a computer, the digital piano can be used as an audio device of your computer.

When you connect the digital piano to a computer, the device driver required to send and receive data will be installed on the computer.

The below instructions explain how to connect and use the terminals.

#### CAUTION - Precautions when using the USB terminal.

When connecting the computer to the USB terminal, make sure to observe the following points. Failing to do so risks freezing the computer and corrupting or losing data. If the computer or the instrument freezes, turn the power to the instrument off and restart the computer.

## Connecting to the Pedal

Insert the pedal plug into the pedal connector on bottom of the piano.

Plug **Pedal cord** which is protruding from the top of the pedal assembly into the corresponding port on underside of the main unit.

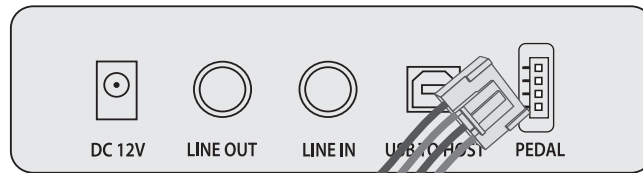

Pedal Cable

### RIGHT PEDAL (Damper Pedal)

With piano tones, depressing the pedal causes notes to linger, much like a piano's damper pedal. With organ tones, depressing the pedal causes notes to continue to sound until the pedal is released.

### CENTER PEDAL (Sostenuto Pedal)

As with the sustain pedal function described above, depressing the sostenuto pedal causes notes to be sustained. This difference between a sostenuto pedal and sustain pedal is the timing. With a sostenuto pedal, you press the keys and then depress the pedal before you release the keys. Only the notes that are sounding when the pedal is depressed are sustained.

### LEFT PEDAL (Soft Pedal)

Depressing the pedal softens the sound of the notes being played.

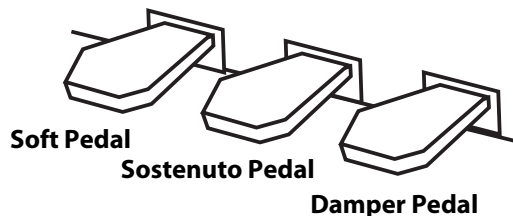

## Control Panel

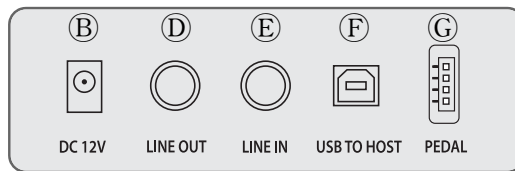
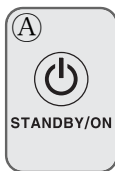
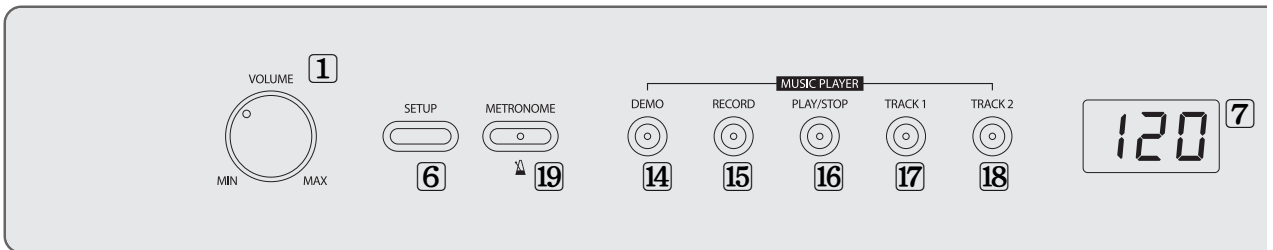

### VOLUME SECTION

- 1 MASTER VOLUME ..... Page 13

### VOICE SECTION

- 2 VOICE buttons ..... Page 13
- 3 SPLIT ..... Page 14
- 4 TWIN PIANO ..... Page 16
- 5 REVERB ..... Page 15

### SETUP SECTION

- 6 SETUP
- 7 LED Display
- 8 DATA UP/DOWN
- 9 TUNE ..... Page 17
- 10 TRANSPOSE ..... Page 17
- 11 TOUCH ..... Page 18
- 12 LOCAL CONTROL ..... Page 18
- 13 ENTER ..... Page 19

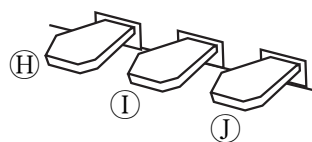
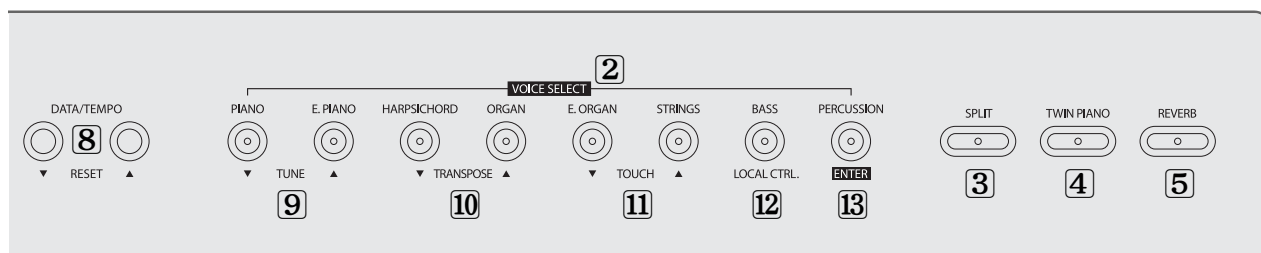

## PLAYER SECTION

- 14 DEMO ..... Page 21
- 15 RECORD ..... Page 20
- 16 PLAY/STOP ..... Page 20, 21
- 17 TRACK 1 ..... Page 20, 21
- 18 TRACK 2 ..... Page 20, 21
- 19 METRONOME ..... Page 16

## POWER

- A POWER SWITCH ..... Page 8
- B DC IN ..... Page 7

## CONNECTOR

- C HEADPHONE ..... Page 8
- D LINE OUT ..... Page 9
- E LINE IN ..... Page 9
- F USB ..... Page 9
- G PEDAL ..... Page 10

## PEDAL

- H SOFT PEDAL ..... Page 10
- I SOSTENUTO PEDAL ..... Page 10
- J DAMPER PEDAL ..... Page 10

# Basic Operation

## Adjusting the Volume

The piano has one volume knob on the panel for adjusting the volume.

### MASTER VOLUME

This determines the entire volume of the piano.

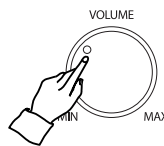

☞ This also determines the volume level of the **HEADPHONE(s)**.

## Selecting Voices

The piano features a wealth of rich, authentic voices, including piano, organ, elec. piano, strings and other instruments. It also features a keyboard percussion function that lets you play realistic drum, percussion sounds, and various effect sounds directly from keyboard.

### Voice Types

- ☞ 14 Sounds
- ☞ 1 Drum kit
- ☞ 1 Sound Effect set

### 1 Select a Voice.

Select the desired voice by pressing the appropriate **VOICE** button.

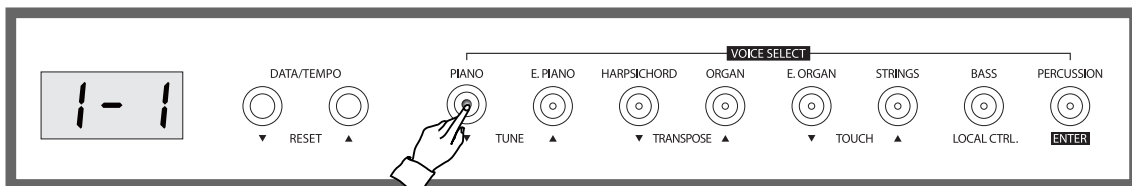

- ☞ The digital piano has 8 voice buttons and a voice button has two assigned voices.
- ☞ When pressing a voice button, the assigned voice number is shown on the display.
- ☞ You can change a voice of the selected button pressing the button again.

### ☞ Backing Up the Selected Voice

The last selected voice in each button will be retained in memory.

## Voice List

Grand Piano	E.Piano	Harpichord	Organ	E.Organ	Strings	Bass	Percussion
Button 1	Button 2	Button 3	Button 4	Button 5	Button 6	Button 7	Button 8
G. Piano 1 G. Piano 2	E.Piano 1 E.Piano 2	Harpichord Vibraphone	Organ 1 Organ 2	E. Organ 1 E. Organ 2	Strings Slow Strings	Acoust. Bass E. Bass	Drum Set Sound Effects

### 2 Play the selected voice.

Adjust the volume by using **MASTER VOLUME** and play the piano with the selected voice.

## Layer

The Layer mode of the piano allows you to select and play two different voices simultaneously in a layer. This makes it easy to create exceptionally rich and thick tonal textures. The volume balance can be set for the two voices.

### 1 Press and hold a main voice and press a layered voice.

Select a voice in the normal way. (See the **SELECTING VOICE** section on page 13.)

- ☞ When you play a key, main voice is played with the layered voice.
- ☞ Volume of the layered voice can be adjusted independently in the setup mode. (See the **SETUP** section on page 19.)

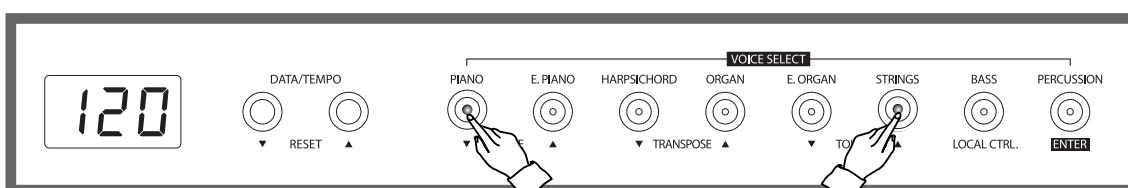

### 2 Press a voice button to release the layered voice.

## Split

The Split mode of the piano allows you to select and play two different voices with your left and right hands - For example, play bass with the left and piano with the right.

## PLAYING WITH SPLIT VOICE

### 1 Select a main voice.

Select a voice in the normal way. (See the **SELECTING VOICE** section on page 13.)

## 2 Call up the Split mode.

To call up the split mode, press the **SPLIT** button. The lamp flashes and the split is set on and the LED display shows current selected split voice.

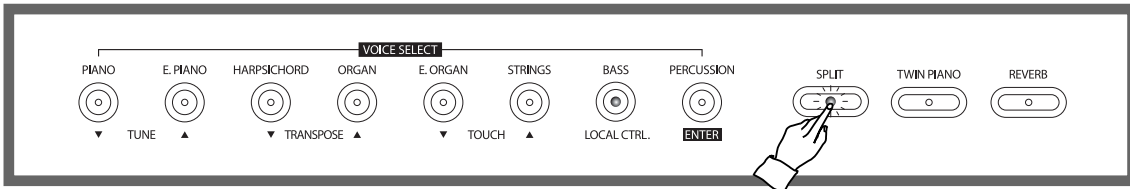

☞ The default voice is '07' **ACOUSTIC BASS** in the split mode.

## 3 Select the split voice.

Press a voice button to select a desired split voice during the split button flashes.

☞ Volume of the split voice can be adjusted independently in the setup mode. (See the **SETUP** section on page 19.)

## Changing the Split Point

You can set the point dividing the right and left keyboard ranges at any desired key position.

**To assign new split point, hold down the SPLIT button and press a key.**  
The LED display shows split key's number.

▼ SPLIT (DEFAULT F#3 , KEY 33)

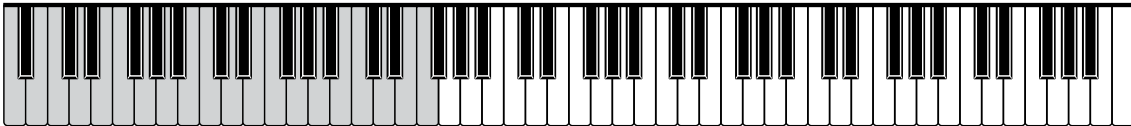

☞ Key number of the lowest note is '00.

## Reverb

Reverb is an effect that recreates the decaying reflections of a sound in a performance space, and reproduces the special ambience of a concert hall.

### REVERB ON/OFF

To turn on reverb, press the **REVERB** button. The lamp lights and the reverb is set ON.

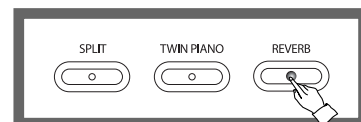

To turn off reverb, press the **REVERB** button again. The lamp turns off and the reverb is no longer activated.

☞ Default is ON.

☞ Reverb type and volume can be adjusted in the setup mode. (See the **SETUP** section on page 19.)



## Using the Metronome

The piano features a convenient metronome that is ideal for practicing.

### START/STOP OF THE METRONOME

To start the metronome, simply press the **METRONOME** button. Press the **METRONOME** button again to stop the metronome sound.

### ADJUSTING THE TEMPO OF THE METRONOME

You can set the tempo over range 20 ~ 280 beats per minute by using the **DATA/TEMPO** buttons.

- ☞ Hold the button for continuous decrementing or incrementing.
- ☞ If you press both **UP** and **DOWN** buttons at the same time, it automatically returns to the default tempo 120.
- ☞ Metronome volume can be adjusted in the setup mode. (See the **SETUP** section on page 19.)

### SELECTING THE BEAT

Metronome sound can be set beat.

While the metronome is on, press and hold the **METRONOME** button to assign the beat for 2 seconds. The LED display shows current beat and you can change it by **DATA UP** or **DOWN** button.



- ☞ To set default 'metronome beat 4' press both **DATA UP** and **DOWN** buttons.
- ☞ **Metronome Beat Range** 1~12

## Twin Piano

The keyboard can be divided into two separate sections, allowing two people to perform in the same octave.

### 1 Selecting a Voice.

Select a voice in the normal way. (See the **SELECTING VOICE** section on page 13.)

### 2 Press the TWIN PIANO button.

The keyboard splits two sections, which have same octave.

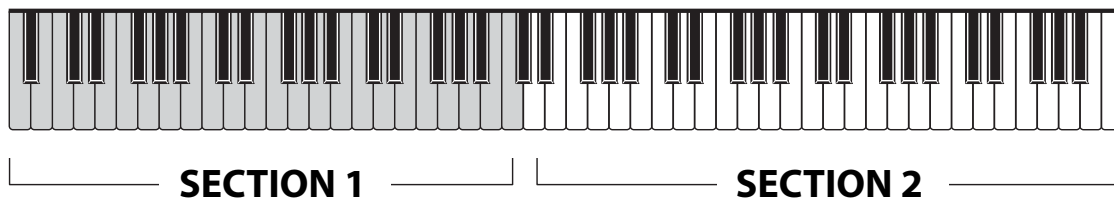

### 3 To turn off the twin piano performance, press the TWIN PIANO button again.

The twin piano performance turns off and the lamp goes out.

# Function

## Tune

The Tune function lets you make fine adjustments to the pitch, allowing you to accurately match the tuning with that of other instruments.

Press and hold down the **SETUP** button and press the **TUNE UP** or **DOWN** button.

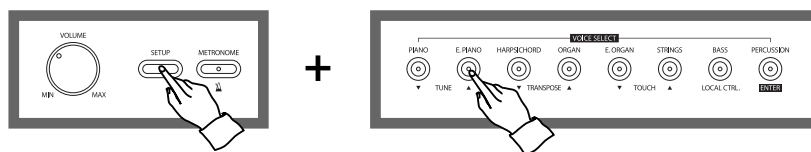

- ☞ The tune pop-up display appears and shows current value.
- ☞ The value can be changed by pressing **TUNE UP** or **DOWN** button.
- ☞ If you press both **UP** and **DOWN** buttons at the same time, it automatically returns to the default value.
- ☞ **Range** -64~ default 00 ~ 64
- ☞ **Hz(Hertz)**  
The pitch is measured in units of Hertz (abbreviated Hz), which represents the number of times the sound wave vibrates in a second.
- ☞ The cent is unit of pitch, equal to 1/100 of a semitone.
- ☞ **Backing Up adjusted value**  
The last adjusted value of each function can be retained in memory.

## Transpose

The TRANSPOSE function makes it possible to shift the pitch of the keyboard in semitone units, allowing you to match the pitch of the keyboard to the range of other instruments or singers, or letting you easily play in a different key without having to change your fingering. For example, if the TRANSPOSE is set F key, playing C results in a pitch of F, or in other words, you can play in the key of C major on the keyboard and automatically have the pitch transposed to F major.

Press and hold down the **SETUP** button and press the **TRANSPOSE UP** or **DOWN** button.

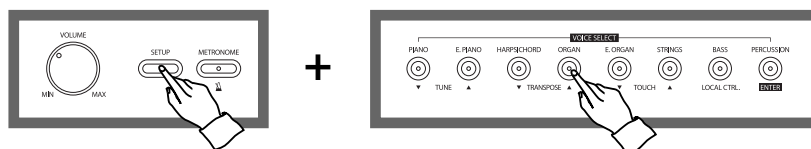

- ☞ The Transpose pop-up display appears and shows current value.
- ☞ The value can be changed by pressing **TRANSPOSE UP** or **DOWN** button.
- ☞ If you press both **UP** and **DOWN** buttons at the same time, it automatically returns to the default value.
- ☞ **Range**: -12 semitone ~ 0 ~ 12 semitone (default 00)
- ☞ **Backing Up adjusted value**  
The last adjusted value of each function can be retained in memory.

## Touch

Touch determines how your playing strength (velocity) affects the volume of the voices. 10 types are available for tailoring the keyboard response to the selected voice, type of song, or your own playing preference.

Press and hold down the **SETUP** button and press the **TOUCH UP** or **DOWN** button.

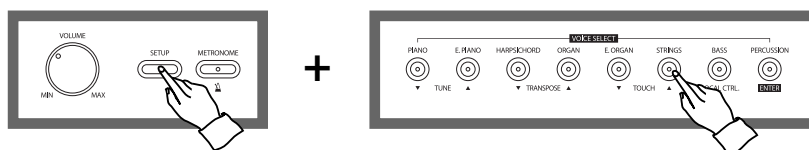

DISPLAY	TOUCH	DESCRIPTION
SoF	Soft	These settings let you produce a relatively loud sound even when playing the key softly.
nor	Normal	These settings are standard keyboard response and the <b>NORMAL</b> is used as the basic setting. (Default)
hrd	Hard	These settings require you to play the keys quite strongly to produce maximum loudness.
oFF	Off	These settings produce the same degree of loudness, no matter how strongly or softly you play the keys.

- ☞ The Touch pop-up display appears and shows current value.
- ☞ The value can be changed by pressing **TOUCH UP** or **DOWN** button.
- ☞ If you press both **UP** and **DOWN** buttons at the same time, it automatically returns to the default value.
- ☞ **Backing Up adjusted value**  
The last adjusted value of each Function can be retained in memory.

## MIDI Local control

Local control refers to the fact that, normally, the piano keyboard controls its internal tone generator, allowing the internal voices to be played directly from the keyboard.

This situation is called Local Control ON. When the local control is set to off, the keyboard and sound source are separated and no sound is heard through the piano when playing the keyboard.

However, the data of the keyboard performance is output through MIDI. By setting local control to off, you can play an external MIDI tone generator from the keyboard of the piano without sounding the internal voices.

To turn off the MIDI local control, press and hold the **SETUP** button and press the **LOCAL CTRL** button.

The LED display shows 'oFF' and the piano goes to the MIDI control off mode.

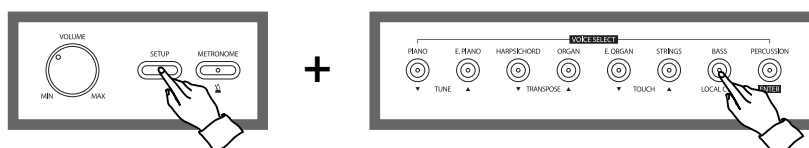

## Sound Setting and Initializing Digital Piano

There are 11 functions to set sound in the setup mode.

### 1 Call up the setup mode.

Press **SETUP** button to call up setup mode . The LED display shows '---

### 2 Select a desired function.

To select a function, press the **DATA/TEMPO UP** or **DOWN** button with holding down the **SETUP** button. Function number will be shown on the LED display.

### Function List

DISPLAY	FUNCTION	DESCRIPTION	RANGE / (DEFAULT)
F01	Main Voice Vol.	Adjust the volume of the main voice.	00 ~ 127 / (127)
F02	Split Voice Vol.	Adjust the volume of the split voice.	00 ~ 127 / (127)
F03	Layered Voice Vol.	Adjust the volume of the layered voice.	00 ~ 127 / (100)
F04	Metronome /Demo Vol.	Adjust volume of metronome & demo music.	00 ~ 127 / (100)
F05	Reverb Type	Select a reverb type. r-0 (Off), r-1 (Room 1), r-2 (Room 2), r-3 (Room 3), r-4 (Hall 1), r-5 (Hall 2), r-6 (Plate), r-7 (Shot Delay), r-8 (Long Delay)	r-0 ~ r-8 / (r-5)
F06	Reverb Vol.	Adjust reverb volume.	00 ~ 127 / (80)
F07	Effect Type	Select a effect type. 00 (Off), 01 (Chorus 1), 02 (Chorus 2), 03 (Chorus 3), 04 (Chorus 4), 05 (Chorus 5), 06 (Delay 1), 07 (Delay 2), 08 (Delay 3), 09 (Flanger), 10 (Feedback 1), 11 (Feedback 2), 12 (Feedback 3), 13 (Feedback 4)	00 ~ 13 / (00)
F08	Effect Vol.	Adjust effect volume.	00 ~ 127 / (36)
F09	Low EQ Level	Low frequency EQ gain	- 06 ~ 00 ~ + 06 (06)
F10	High EQ Level	High frequency EQ gain	- 06 ~ 00 ~ + 06 (00)
F11	Initialize	The digital piano goes to factory setting.	-

### 3 Adjust value of the selected function.

Press the **ENTER/PERCUSSION** button with holding down the **SETUP** button.

The LED display shows a value of the selected function and you can adjust the value by using **DATA/TEMPO UP** or **DOWN** button.

- ☞ If you press both **DATA/TEMPO UP** and **DOWN** buttons, it automatically returns to the default value.
- ☞ Hold the button for continuous decrementing or incrementing.

# Recording

The piano features comprehensive song recording functions that allow you to record your own performance. A song records 2 tracks and approx. 9,000 notes can be recorded into one track. You can record total 3 songs in the piano.

## Recording and Playback



### 1 Prepare recording to the Track 1

Select the desired voice and press both the **RECORD** and the **TRACK 1** buttons. The record button turns on and the track1 button flashes.

### 2 Start recording to the Track1.

Recording starts when playing the keyboard or pressing the **PLAY** button. Both buttons flash.

☞ When record of the tack1 starts, old data of the track 1 is deleted.

### 3 Stop recording to the Track1.

Recording stops when pressing the **TRACK1** button or **RECORD** button. The record button turns off and the track 1 button turns on.

If you want to hear the recorded song in the Track1, press the **PLAY** button. Playback of the track1 starts with flashing the play button.

### 4 Start recording to the Track2.

Press both the **RECORD** and **TRACK 2** button. The record button turns on and the track2 button flashes.

Recording starts when playing the keyboard or pressing the **PLAY** button.

Accompaniment cannot be recorded into the track2.

☞ If you want to hear playback of the track1, turn on the track1 by pressing the **TRACK1** button. If not, turns off the track1.

☞ Each track independently can be played.

### 5 Stop recording to the Track2.

Recording stops when pressing the **TRACK2** button or **RECORD** button. The record button turns off and the track 2 button turns on.

If you want to hear the recorded song in the track2, press the **PLAY** button. Playback of the track2 starts with flashing the play button.

### 6 Playback the recorded song.

Press the **PLAY** button. Playback of the recorded song starts.

☞ If there is a recorded song in the track memory, the track lamp lights.

☞ If you turn off a track, piano does not play the track.

### 7 Stop playback of the recorded song.

Press the **PLAY** button again. Playback of the recorded song stops.

#### **CLEARING RECORDED MEMORY**

Press both **RECORD** and **PLAY** buttons. The recorded data is deleted in the tracks.

☞ When you recorded a new song into a track, old data is deleted in the track.

#### ☞ **Backing Up the recorded song**

Even if the power is turned off, the recorded song memory is not deleted.

# Demo Music

Your piano comes with 50 piano music. You can playback the demo music for your own listening pleasure, or you can use them for practice.

## Playback of the Music



### 1 Enter the demo music mode.

Press the **DEMO MUSIC** button. The LED display shows 'd01' that is first number of the music.

### 2 Select a desired music.

Change the number of the music by using **DATA UP** or **DOWN** button.

- ☞ There are 50 tunes in the music demo.
- ☞ Refer to the **MUSIC LIST**.

### 3 Playback of the selected music.

Press the **PLAY/STOP** button. The selected music starts.

### 4 Stop music.

Press the **PLAY/STOP** again. The music stops.

## Demo Music List

Display	Title	Composer
d 01	Etude op.10 no.1	Chopin, Fryderyk Franciszek
d 02	Etude op.10 no.4	
d 03	Etude op.10 no.5	
d 04	Etude op.25 no.9	
d 05	Nocturne op.9 no.1	
d 06	Nocturne op.9 no.2	
d 07	Nocturne op.27 no.2	
d 08	Nocturne op.32 no.1	
d 09	Nocturne op.72 no.1	
d 10	Sonata op.3 no.4	
d 11	Mazurka op.7 no.1	
d 12	Mazurka op.30 no.2	
d 13	Mazurka op.67 no.3	
d 14	Polonaise op.40 no.1	
d 15	Waltz op.34 no.1	
d 16	Waltz op.64 no.1	
d 17	Waltz op.64 no.2	
d 18	Waltz op.69 no.2	
d 19	Impromptu No. 4 c sharp minor (Fantasie-Impromptu) Op.66	
d 20	Ballade op.23 no.1 in g minor	
d 21	Ballade op.47 no.3 in A flat Major	
d 22	Prelude op.28 no.1 in C Major- Agitato	
d 23	Prelude op.28 no.16 in b-flat minor- Presto con fuoco	
d 24	Piano Sonata no.10 in C major, KV330 I. Allegro moderato	Mozart, Wolfgang Amadeus
d 25	Piano Sonata no.11 in A major, KV331 I. Alla turca : Allegretto	
d 26	Piano Sonata no.14 in c minor, KV457 I. Adagio	
d 27	Piano Sonata no.14 in c minor, KV457 III. Assai allegro	
d 28	Variations "Ah! Vous dirai-je, Maman"	
d 29	Rondo in D major, KV485	
d 30	Sonate no.8 in c minor, op.13 'Pathetique' Grave - Allegro molto e con brio	Beethoven, Ludwig van
d 31	Sonate no.8 in c minor, op.13 'Pathetique' II. Adagio cantabile	
d 32	Sonate no.8 in c minor, op.13 'Pathetique' III. Allegro	
d 33	Arabesque No.1 in E major	Debussy, Claude Achille
d 34	Suite bergamesque 1. Prelude	
d 35	Suite bergamesque 3. Clair de lune	
d 36	Petite Suite, for piano 4-hands 2. Cortège	
d 37	Scenes from Childhood op.15 From foreign lands and peoples in G major	Schumann, Robert Alexander
d 38	"12 Etudes d'execution transcendante (Transcendental Etudes), S 139 Etude Transcendante in d minor, Mazeppa	Liszt, Franz
d 39	The flight of the bumble bee (by S. Rachmaninov)	Rimsky, Korsakov
d 40	Trois Gymnopedies 1. Lent et douloureux	Satie, Erik
d 41	12 Fantasie per clavicembalo (TWV 33) - Harpsichord music - 1. Fantasia	Telemann, Georg Philipp
d 42	12 Fantasie per clavicembalo (TWV 33) - Harpsichord music - 3. Fantasia	
d 43	12 Fantasie per clavicembalo (TWV 33) - Harpsichord music - 5. Fantasia	
d 44	12 Fantasie per clavicembalo (TWV 33) - Harpsichord music - 6. Fantasia	
d 45	12 Fantasie per clavicembalo (TWV 33) - Harpsichord music - 12. Fantasia	
d 46	Children's Album, Op.39 No.4 Mama	Tchaikovsky, Pyotr Ilyich
d 47	Prelude in C major, BWV933	Bach, Johann Sebastian
d 48	Praludium und Fuge in B BWV560 -Pipe Organ music -	
d 49	Wohltemperriertes Klavier-Pledudio 1	
d 50	Wohltemperriertes Klavier-Fuga 1	

# Drum and SFX Table

	Prog 1 Standard Drum (8-1)	Prog 57 SFX 2 (8-2)
27 - D#1	High Q	
28 - E1	Slap	
29 - F1	Scratch Push	
30 - F#1	Scratch Pull	
31 - G1	Sticks	
32 - G#1	Square Click	
33 - A1	Metronome Click	
34 - A#1	Metronome Bell	
35 - B1	Kick drum2/Jazz BD2	
36 - C1	Kick drum1/Jazz BD1	
37 - C#2	Side Stick	
38 - D2	Snare Drum1	
39 - D#2	Hand Clap	High Q
40 - E2	Snare Drum 2	Slap
41 - F2	Low Floor Tom	Scratch Push
42 - F#2	Closed Hi Hat [EXC1]	Scratch Pull
43 - G2	High Floor Tom	Sticks
44 - G#2	Pedal Hi-Hat [EXC1]	Square Click
45 - A2	Low Tom	Metronome Click
46 - A#2	Open Hi-Hat [EXC1]	Metronome Bell
47 - B2	Low-Mid Tom	Guitar Slide
48 - C2	Hi Mid Tom	Gt Cut Noise 1
49 - C#3	Crash Cymbal 1	Gt Cut Noise 2
50 - D3	High Tom	Double Bass Slap
51 - D#3	Ride Cymbal 1	Key Click
52 - E3	Chinese Cymbal	Laughing
53 - F3	Ride Bell	Screaming
54 - F#3	Tambourine	Punch
55 - G3	Splash Cymbal	Heart Beat
56 - G#3	Cowbell	Footsteps 1
57 - A3	Crash Cymbal2	Footsteps 2
58 - A#3	Vibraslap	Applause
59 - B3	Ride Cymbal2	Door Creaking
60 - C4	Hi Bongo	Door Closing
61 - C#4	Low Bongo	Scratch
62 - D4	Mute Hi Conga	Wind Chime
63 - D#4	Open Hi Conga	Car Engine Start
64 - E4	Low Conga	Car Breaking
65 - F4	High Timbale	Car Pass
66 - F#4	Low Timbale	Car Crash
67 - G4	High Timbale	Police Siren
68 - G#4	Low Agogo	Train
69 - A4	Cabasa	Jet Take-off
70 - A#4	Maracas	Helicopter
71 - B4	Short Whistle[EXC2]	Starship
72 - C5	Long Whistle[EXC2]	Gun Shot
73 - C#5	Short Guiro[EXC3]	Machinegun
74 - D5	Long Guiro[EXC3]	Lasergun
75 - D#5	Claves	Explosion
76 - E5	Hi Wood Block	Dog
77 - F5	Low Wood Block	Horse Gallop
78 - F#5	Mute Cuica[EXC4]	Birds
79 - G5	Open Cuica[EXC4]	Rain
80 - G#5	Mute Triangle[EXC5]	Thunder
81 - A5	Open Triangle[EXC5]	Wind
82 - A#5	Shaker	Sea Shore
83 - B5	Jingle Bell	Stream
84 - C6	Belltrees	Bubble
85 - C#6	Castanets	
86 - D6	Mute Surdo[EXC6]	
87 - D#6	Open Surdo[EXC6]	
88 - E6		



# MIDI Implementation

Function			Recognized	Transmitted	Remark
Basic Channel	Default		ALL	1-3	
Mode	Default		OMNI OFF, POLY	OMNI OFF, POLY	
Note ON/OFF	9nH kk vv		O	O	#kk:note ON (0-127) #vv:velocity (1-127)
Pitch Bender	EnH bi bh		O	O	Maximum swing +/- 1 tone
Control Change	00	BnH 00H cc	O	X	Bank Select
	01	BnH 01H cc	O	X	Modulation Wheel
	05	BnH 05H cc	O	X	Portamento Time
	06	BnH 06H cc	O	X	Data Entry
	07	BnH 07H cc	O	X	Volume
	10	BnH 0AH cc	O	X	Pan Out
	11	BnH 0BH cc	O	X	Expression
	64	BnH 40H cc	O	O	Sustain (Damper) Pedal
	65	BnH 41H cc	O	X	Portamento ON/OFF
	66	BnH 42H cc	O	O	Sostenuto Pedal
	67	BnH 43H cc	O	O	Soft Pedal
	80	BnH 80H w	O	X	Reverb Prog.(vw=00H-70H)
	81	BnH 51H w	O	X	Chorus Prog.
	91	BnH 5BH w	O	X	Reverb Send Level
	93	BnH 5DH w	O	X	Chorus Send Level
120	BnH 78H 00H	O	X	All Sound Off	
121	BnH 79H 00H	O	X	Reset All Controller	
123	BnH 7BH 00H	O	X	All Notes Off	
126	BnH 7EH 00H	O	X	Mono On	
127	BnH 7FH 00H	O	X	Poly On	
Program Change	CnH PP		O	O	Sounds/Drum Set List
System Exclusive	General MIDI Reset		X	X	

O:Yes, X:No

# Troubleshooting

※ Be sure to check to following table whenever you encounter problems with the DIGITAL PIANO operation.

<b>PROBLEM</b>	<b>CAUSE</b>	<b>SOLUTION</b>
<b>No sound</b>	1. Power supply problem. 2. Volume setting is too low. 3. Headphone is plugged in.	1. Check the power cord whether it's properly in AC outlet. 2. Adjust the volume. 3. Unplug the headphone.
<b>Occasional interference</b>	1. Refrigerators, washing machines and similar electric appliances are interfering.	1. Use outlet as far away as possible from appliance thought to be the cause.
<b>No sound when connected to external amplifier.</b>	1. Volume setting is too low. 2. Defective connection cord.	1. Adjust the volume. 2. Replace connection cord.

# Specifications

<b>Section</b>	<b>Contents</b>
<b>PRODUCT</b>	DIGITAL PIANO
<b>KEYBOARD</b>	88 KEYS (STANDARD) - 7 1/4 OCTAVES
<b>TOUCH RESPONSE</b>	OFF, SOFT, NORMAL, HARD
<b>MAX. POLYPHONY</b>	32 NOTES
<b>SOUND</b>	14 VOICES 1 DRUM KIT, 1 SOUND EFFECT SET
<b>FUNCTIONS</b>	LAYER, SPLIT, TUNE, TRANSPOSE, MIDI LOCAL CONTROL, PEDAL
<b>DIGITAL SIGNAL PROCESSING</b>	EFFECT(13), REVERB(8)
<b>METRONOME</b>	YES
<b>DISPLAY</b>	LED MULTI FUNCTION DISPLAY
<b>DEMO MUSIC</b>	50 TUNES
<b>RECORD</b>	REAL-TIME-RECORDING 2 TRACKS APPROX. 18,000 NOTES (9,000 NOTES/TR)
<b>VOLUME CONTROLS</b>	MAIN, LAYER, SPLIT, DEMO. METRONOME LOW EQ GAIN, HIGH EQ GAIN, REVERB, EFFECT
<b>I/O TERMINALS</b>	USB IN, PEDAL IN STEREO LINE IN STEREO LINE OUT 2 HEADPHONE JACKS
<b>SPEAKER</b>	6.5 INCHES × 2 (STEREO 15W + 15W)
<b>POWER</b>	DC IN (12V)

